

PowerAmp Design

EVALUATION KIT FOR MODELS PAD135/ PAD183

EVAL135

Rev D

INTRODUCTION

The EVAL135 evaluation kit provides a convenient method to become familiar with the operation of the PAD135 or PAD183 Compact High Voltage Op Amps before your application circuit is committed to production. Some assembly is required since user selections are needed depending on the application. For example, there are several PCB mounting options available.

Critical connections for power supply bypassing and compensation are pre-wired. Connections are also provided for diode clamps on each power supply and the output for additional amplifier protection. Terminal strips are provided for input and output signals and power.

ASSEMBLY STEPS

Please note that the #1 cause of problems for evaluation kit users is not reading and following the directions (all of them). The #2 cause of problems is poor solder joints (cold or bridging). Don't become a statistic. ✓ each step.

Refer to the Illustrated Parts List for the components mentioned in the assembly steps.

- 1. Notice that the printed circuit board (PCB) is labeled on one side as the "DUT SIDE" and the other side as "CIRCUIT" side.
- 2. D3 and D5 are transient voltage suppressor diodes and are not supplied since the type (breakdown voltage) varies with the application. They are not necessary for every application. They are most commonly used in application circuits where kickback from the load may force the supply voltage above the limits of the amplifier.
- 3. The evaluation kit PCB can be mounted in several ways:
Option 1- Chassis mount. Use #6 standoffs and screws (not supplied) attached to the PCB at the four corners of the PCB.
Option 2- Bench-top mount. Use the five rubber bumpers supplied. These are "stick-on" components. Remove the release paper from each bumper and apply the bumper to the square outlines on the "CIRCUIT SIDE" of the PCB.
Option 3- DIN rail mount. The PCB can be mounted to a 35mm DIN rail. For mounting the PCB to a DIN rail press the adaptors into the PCB in the holes at the edges of the PCB at locations 1 and 2 from the "CIRCUIT SIDE" of the PCB. Make sure that the plastic tines have fully spread out on the "DUT SIDE" of the PCB.
- 4. Remove the 4 hex nuts from the mounting spacers of the PAD135 or PAD183.











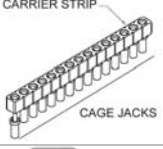

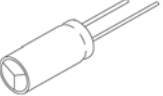
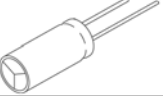

Assembled EVAL135 with amplifier installed.

- 5. Align the 4 studs of the mounting spacers with the mounting holes in the PCB. Be sure that the amplifier's pin 1 aligns with pin 1 on the PCB. Slowly lower the amplifier into the PCB, making sure that the pins of the amplifier and the cage jacks mate. Push the amplifier into the PCB until the mounting spacers meet the PCB.
- 6. Fasten the amplifier to the PCB with the 4 hex nuts previously removed. Do not over-tighten the nuts as this may strip the mounting studs. The provided plastic nut starter can assist you here.
- 7. If necessary, strip 1/8" of insulation from the wires connected to the fan. Twist and tin the wire ends. Insert the red wire into the cage jack labeled "+" at the location marked "FAN" on the PCB. Likewise insert the blue or black wire into the cage jack labeled "-" at the location marked "FAN". Do not solder the wires into the sockets.
- 8. Use the bread-boarding area to add the external components necessary to program the amplifier gain and other circuit requirements to evaluate your application circuit. You can use the evaluation kit schematic and PCB views to map out your circuit.
- 9. Remember that the PAD135 or PAD183 **must** be compensated to operate correctly. See the PAD135 or PAD183 datasheet on Page 4, under PHASE COMPENSATION. The selected phase compensation capacitor will be installed at "C_C" on the evaluation kit PCB. A 47pF capacitor has already been installed in your kit. Another value may better suit your application. Remove and replace the capacitor as necessary for your application. Other compensation capacitors are also included with the kit. C_C must be rated for at least 200V or 350V respectively for the PAD135 or PAD183. A temperature stable type capacitor is required—an X7R ceramic, for example, or an NPO type (preferred).

- 11.** The evaluation kit assembly is complete. Be sure you have read and followed all the assembly steps. Inspect the circuit board for solder shorts or poor solder joints. An illuminated magnifier is helpful.
- 12.** Before applying power to your circuit set the power supply for $\pm 20\text{V}$ and set the power supply current limit to approximately 100mA. Use little or no load at first. Apply an input signal and check the output with an oscilloscope to verify proper functionality. This step can prevent damaging the amplifier or the circuit board should there be some mistake in assembly.

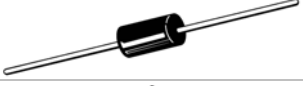
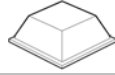
Note that the PAD135 or PAD183 is purchased separately.

✓	Ref	Qty	Description	Mfg/Distributor	Mfg. Part Number	Illustration (not to scale)
<input type="checkbox"/>	Amplifier Pins 1-22 + TPs	1	Cage Jacks w/carrier strip 32 wide	Power Amp Design	CJS01	
<input type="checkbox"/>	C1,2,5,6	4	Chip Capacitor, 0.1µF, 630V	TDK	FK22X7R2J104K	
<input type="checkbox"/>	C3, 4	2	Electrolytic Capacitor, 100µF, 350V	Panasonic/Digi-Key	EEU-EB2V101	
<input type="checkbox"/>	C7	1	Electrolytic Capacitor, 47µF, 35V	Panasonic/Digi-Key	EEU-FC1V470	
<input type="checkbox"/>	JP1	1	BNC Jack	AMP/Digi-Key	5221123-2	
<input type="checkbox"/>	JP2	1	Terminal Block, 5 position	Phoenix/Digi-Key	1729157	
<input type="checkbox"/>	JP3	1	Terminal Block, 7 position	Phoenix/Digi-Key	1729173	
<input type="checkbox"/>	Cc	1	Capacitor, 47pF, 1kV	Sprague/Mouser	561R10TCCQ47	
<input type="checkbox"/>	Cc	1	Capacitor, 10pF, 1kV	Kemet/Mouser	561R10TCCQ10	
<input type="checkbox"/>	Cc	1	Capacitor, 22pF, 1kV	Kemet/Mouser	561R10TCCQ22	
<input type="checkbox"/>	Cc	1	Capacitor, 150pF, 1kV	Kemet/Mouser	561R10TCCT15	
<input type="checkbox"/>	D4, 6	2	Diode, Fast Recovery	ON Semi/Digi-Key	MUR460RL	
<input type="checkbox"/>	NA	5	Rubber Bumper	3M/Digi-Key	SJ5518	
<input type="checkbox"/>	NA	1	Nut Starter	Menda/Jensen Tool	200	
<input type="checkbox"/>	NA	2	35mm DIN Rail Adaptor	Scidyne	121-0014	
<input type="checkbox"/>	NA	1	PCB	Power Amp Design	EVAL135	NA

CIRCUIT DIAGRAM

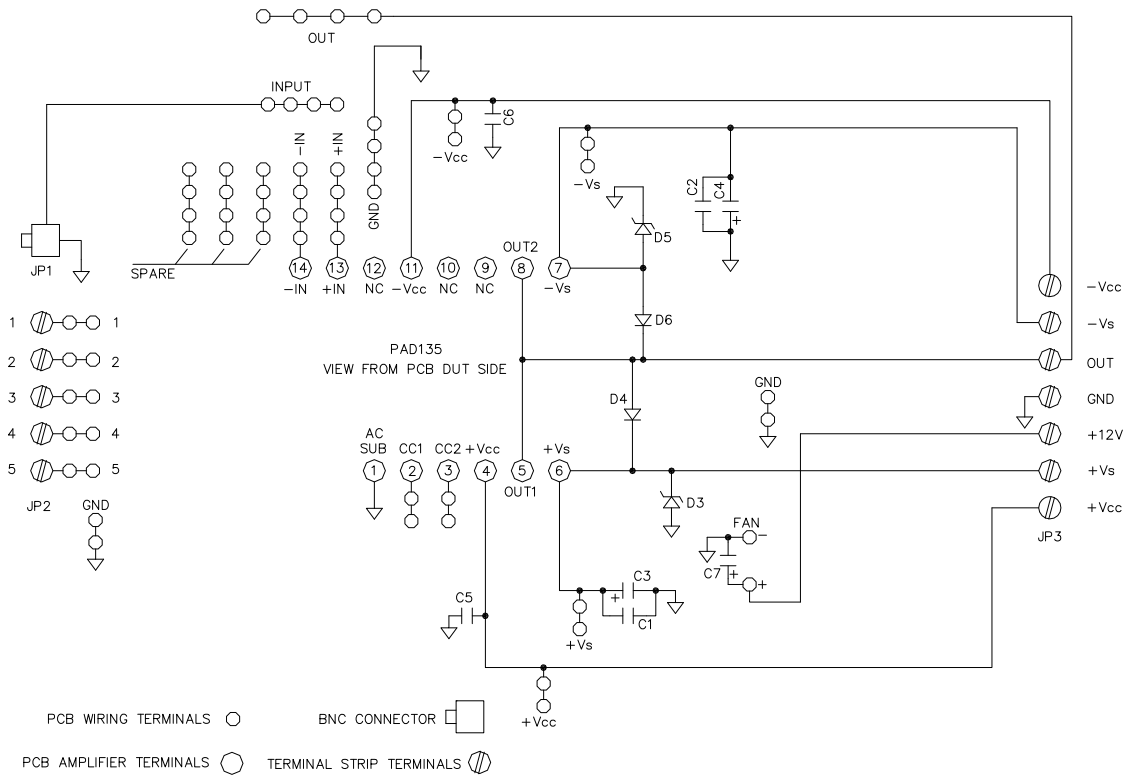

Power Amp Design ♦ EVAL135 ♦ EVALUATION KIT FOR PAD135/PAD183

TOP VIEW

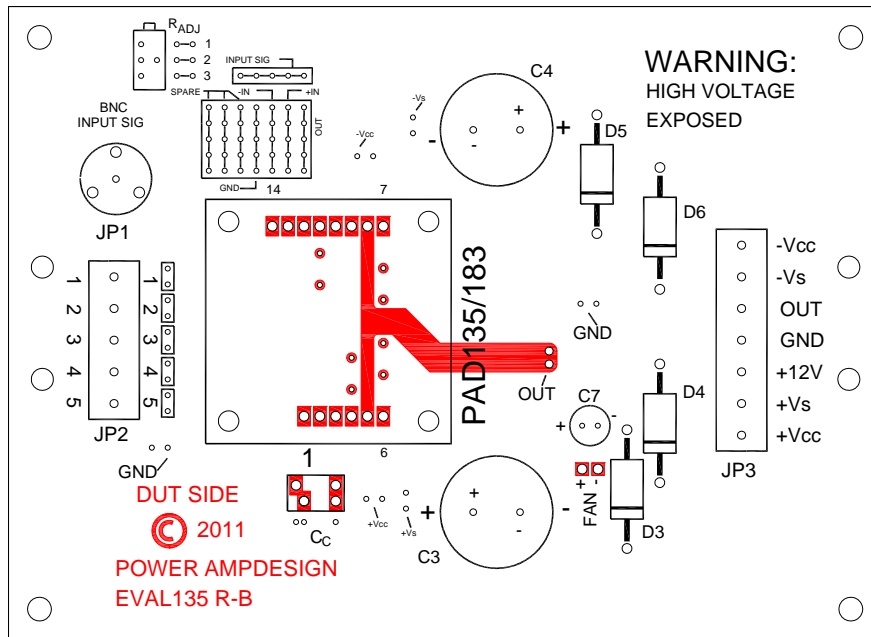

BOTTOM VIEW

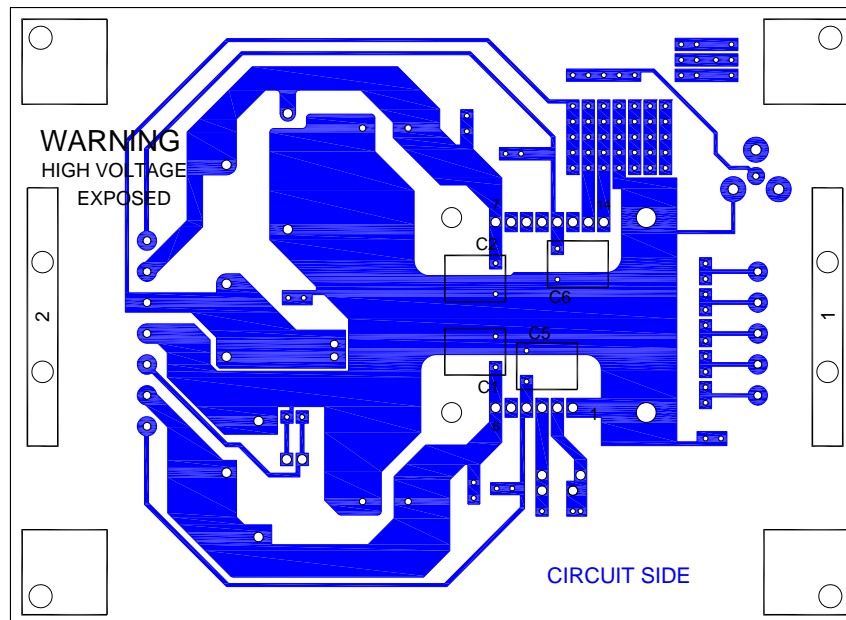

Power Amp Design ♦ EVAL135 ♦ EVALUATION KIT FOR PADI35/PADI183

ASSEMBLED EVAL135 WITH AMPLIFIER INSTALLED



PowerAmp Design ♦ EVAL135 ♦ EVALUATION KIT FOR PAD135/PAD183

TOP VIEW

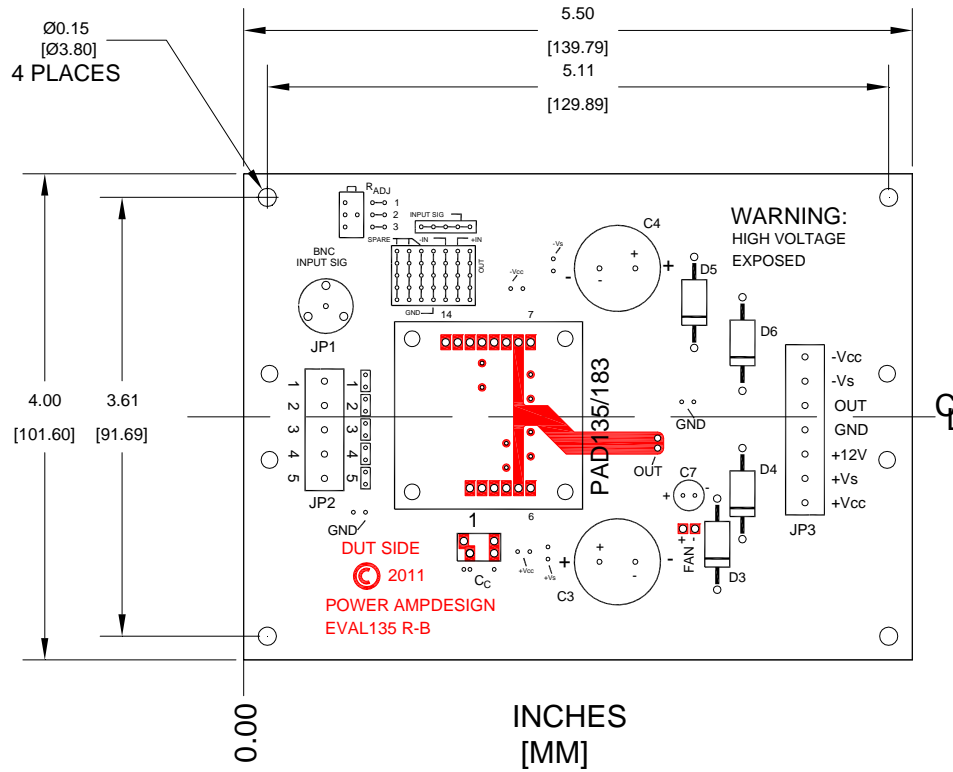

PowerAmp Design ♦ EVAL135 ♦ EVALUATION KIT FOR PAD135/PAD183